

Art.Nr. 12050901

Dichtungssatz Pumpe und Behälter | Gasket set pump and tank | Jeu de joints pour pompe et récipient | Set di guarnizioni pompa e serbatoio

Spray-Matic 10 B

Für Spray-Matic 10 B ab 2019
 For Spray-Matic 10 B from 2019
 Pour Spray-Matic 10 B à partir de 2019
 Per Spray-Matic 10 B dal 2019

2	Dichtung Gasket Joint Guarnizione	108 x 7
15	O-Ring O-ring Joint torique O-ring	31.34 x 3.53
7	O-Ring O-ring Joint torique O-ring	26 x 3
17	O-Ring O-ring Joint torique O-ring	23.47 x 2.62
5	O-Ring O-ring Joint torique O-ring	22 x 2
11	O-Ring O-ring Joint torique O-ring	15 x 3 (3 x)
10	Filter Filter Filtre Filtro	



Für Spray-Matic 10 B bis 2018
 For Spray-Matic 10 B to 2018
 Pour Spray-Matic 10 B à 2018
 Per Spray-Matic 10 B a 2018

2	Dichtung Gasket Joint Guarnizione	108 x 7	
13	17	O-Ring O-ring Joint torique O-ring	31.34 x 3.53 (2 x)
17	O-Ring O-ring Joint torique O-ring*	31 x 4	
15	O-Ring O-ring Joint torique O-ring	23.47 x 2.62	
8	O-Ring O-ring Joint torique O-ring	19.5 x 3	
5	O-Ring O-ring Joint torique O-ring	11.11 x 1.78	
10	Flachdichtung Gasket Joint Guarnizione	14 x 9 x 1.5	

* Für Geräte der Produktionsjahre 2008 bis 2011
 For devices of the production years 2008 to 2011
 Pour les appareils des années de production 2008 à 2011
 Per i dispositivi degli anni di produzione dal 2008 al 2011

i Rückseite beachten
 Note back
 Veuillez lire le verso
 Nota sul retro

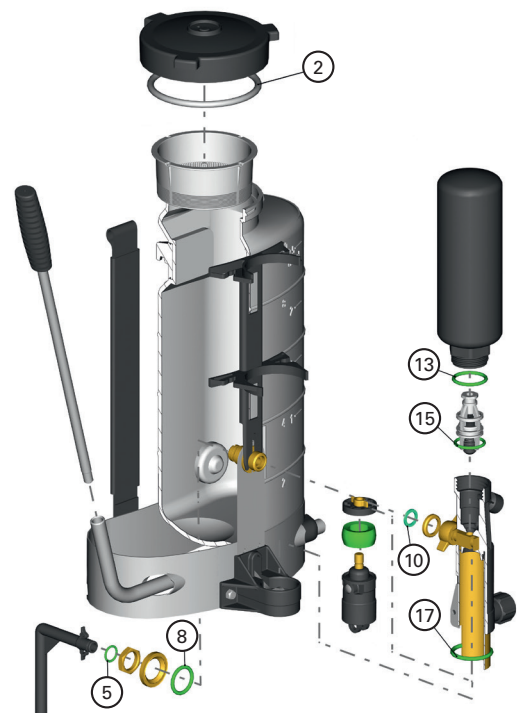

Art.Nr. 12050901

Dichtungssatz Pumpe und Behälter | Gasket set pump and tank | Jeu de joints pour pompe et récipient | Set di guarnizioni pompa e serbatoio

Spray-Matic 10 B

O-Ring
O-ring
Joint torique
O-ring

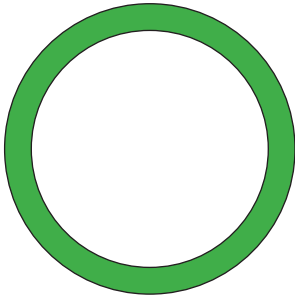

13 15 17 31.34 x 3.53 (2 x)

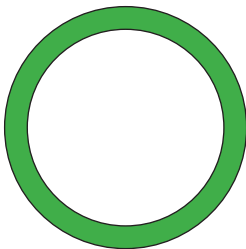

7 26 x 3

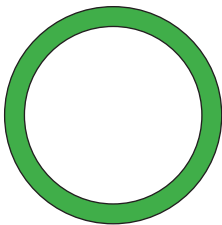

15 17 23.47 x 2.62

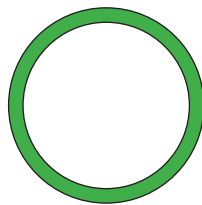

5 22 x 2

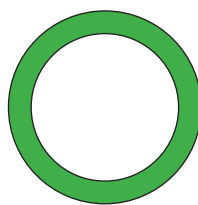

8 19.5 x 3

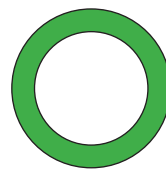

11 15 x 3 (3 x)

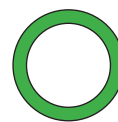

5 11.11 x 1.78

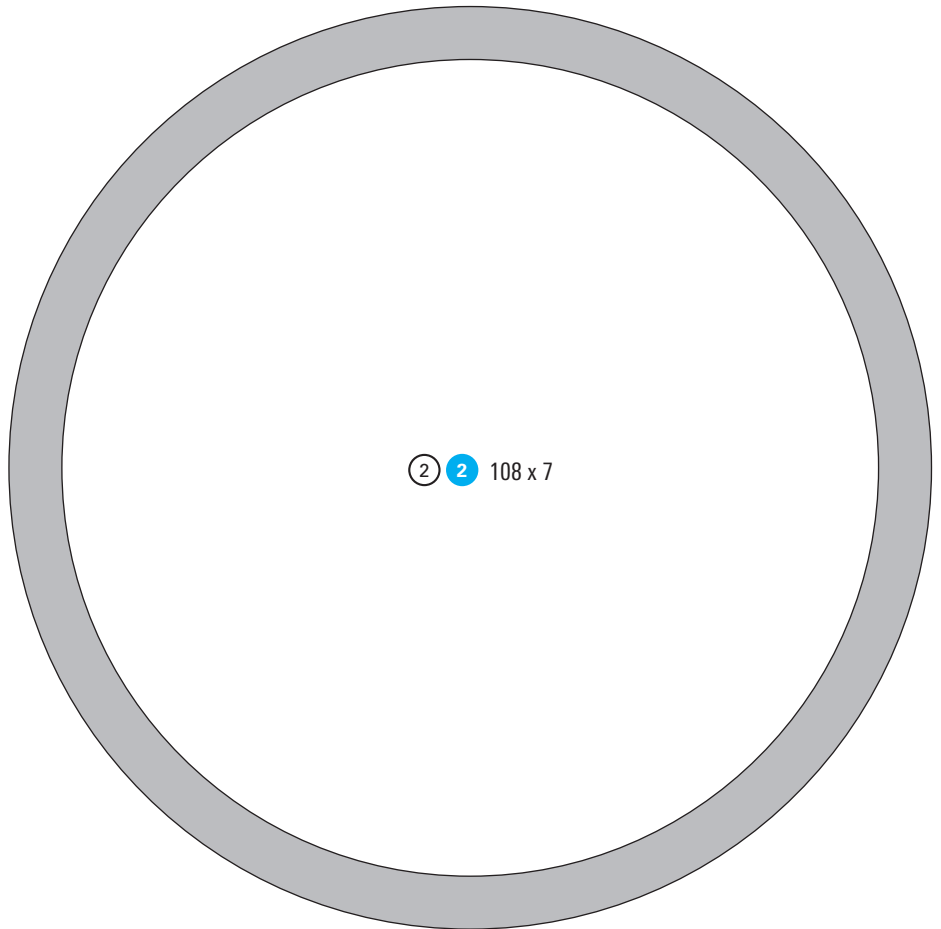

2 2 108 x 7

Flachdichtung
Gasket
Joint
Guarnizione



10 14 x 9 x 1.5

Filter
Filter
Filtre
Filtro

10

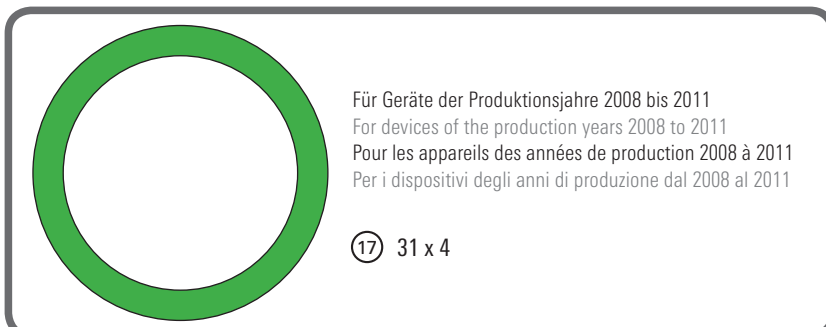
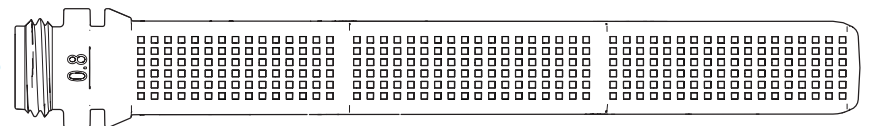

Für Geräte der Produktionsjahre 2008 bis 2011
For devices of the production years 2008 to 2011
Pour les appareils des années de production 2008 à 2011
Per i dispositivi degli anni di produzione dal 2008 al 2011

17 31 x 4

● Version ab 2019
Version from 2019
Version à partir de 2019
Versione dal 2019

○ Version bis 2018
Version to 2018
Version à 2018
Versione a 2018